

Working with Clients with Mental Illness and Intellectual Disabilities

A Workshop for Public Defenders and Assigned Counsel

Northeast Ohio Medical University
June 21, 2017



This project funded by the Ohio Department of Mental Health & Addiction Services

CJ CCOE MISSION AND GOALS:

- Established in May 2001 through Summit ADM via funding from OhioMHAS
- Promote alternatives to divert people with mental illness from jail/justice system and keep them in treatment
- Encourage collaborative relationships and promote cross-system sharing between mental health and criminal justice systems
- Promote utilization of Best Practices
- Develop education and training materials

ACKNOWLEDGMENTS:

- Ohio Department of Mental Health and Addiction Services
- Office of Criminal Justice Services
- Ohio Attorney General's Office
- Fred Osher, M.D. and the Council of State Governments Justice Center
- Policy Research Associates
- Bureau of Justice Assistance, DOJ
- Margaret Clark Morgan Foundation
- Retired Justice Stratton & *Stepping Up* Ohio
- NAMI Ohio

WORKSHOP CO-SPONSORS:

- Ohio Department of Mental Health and Addiction Services
- *Stepping Up Initiative* – The Ohio Project
- Ohio Disability Rights Law and Policy Center, Inc.
- Cuyahoga County Ohio, Common Pleas Court
- David H. Brown, Attorney at Law
- Northeast Ohio Medical University, CJ CCoE
- Ohio Public Defender Office
- Maricopa County, AZ, Office of the Legal Advocate

WORKSHOP PLANNING TEAM:

- David H. Brown LLC
- Haley Durig, CJ CCoE
- Dorian Hall, OPDO
- Kristen Henry, DRO
- Peter Morey, MD, Esq
- Meghan E. Patton, CCCP
- Ruth H. Simerera, CJ CCoE
- Julie Spohn, OhioMHAS

ADULT CORRECTIONAL POPULATION

1980 – 2014 (BUREAU OF JUSTICE STATISTICS)

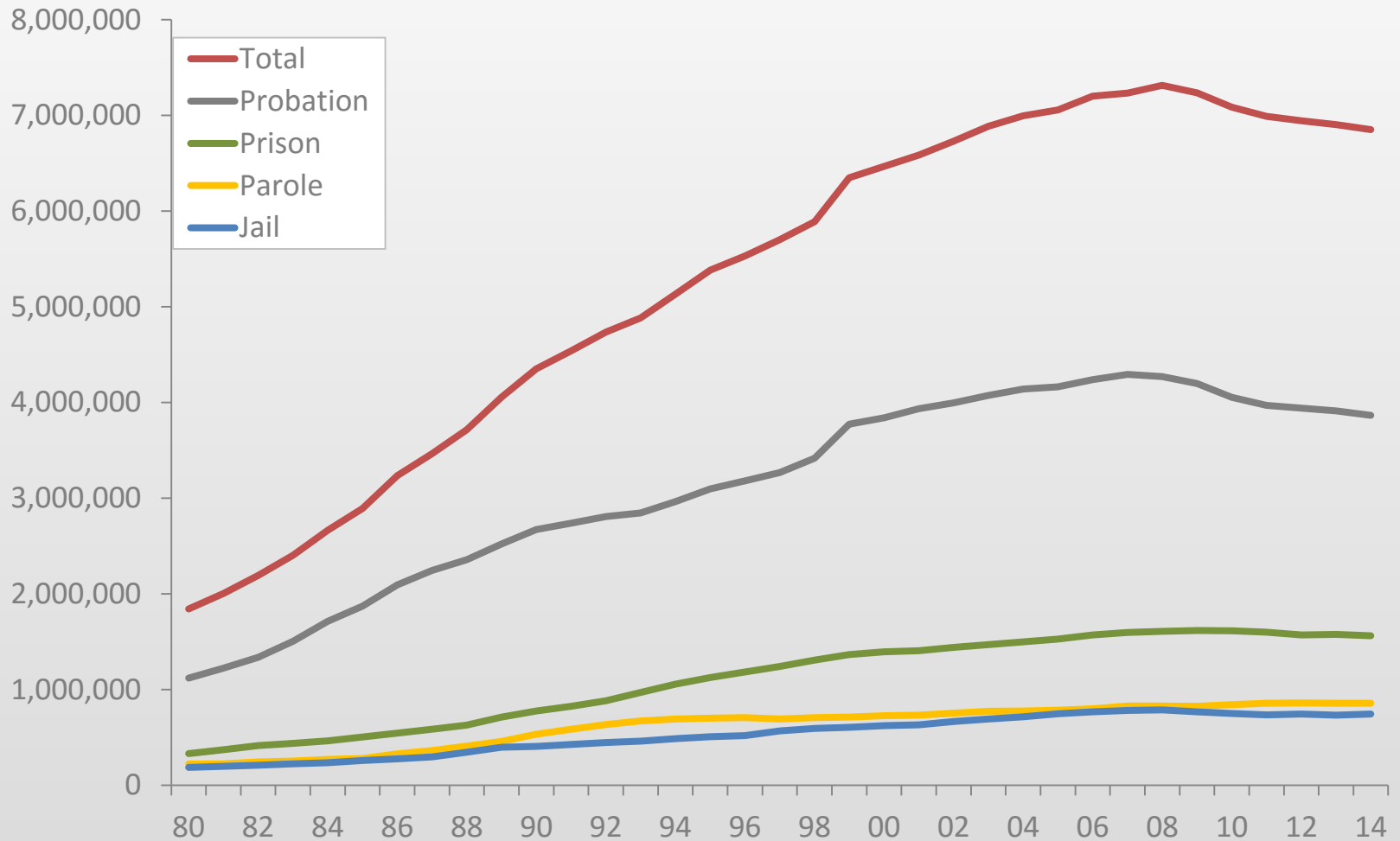

NOT ALL MENTAL ILLNESSES ARE ALIKE: MENTAL ILLNESS IN THE GENERAL POPULATION

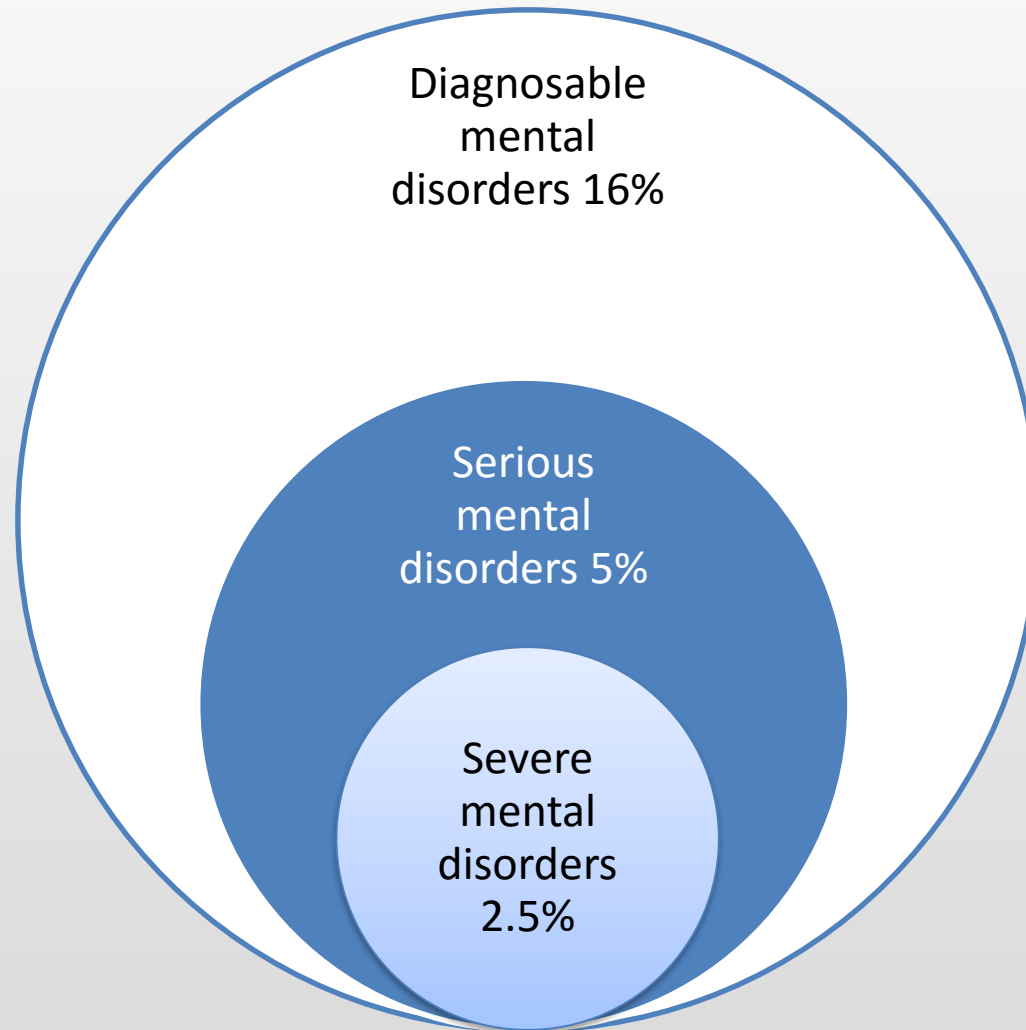

MENTAL ILLNESSES: OVERREPRESENTED IN JAILS AND PRISONS

General Population

5% Serious Mental Illness

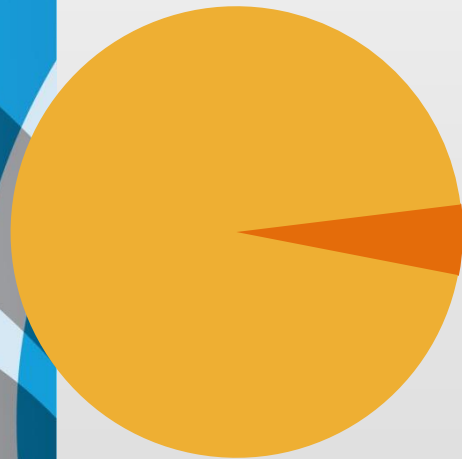

Correctional Population

17% Serious Mental Illness

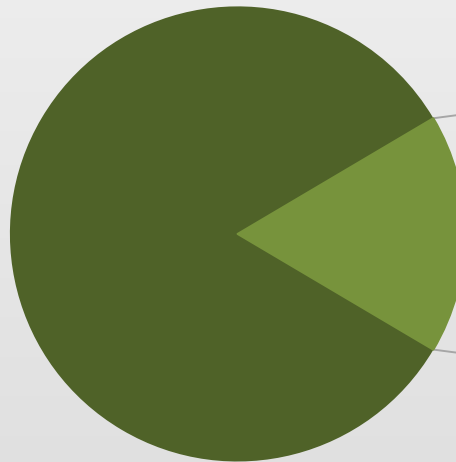

72% Co-Occurring Substance Use Disorder

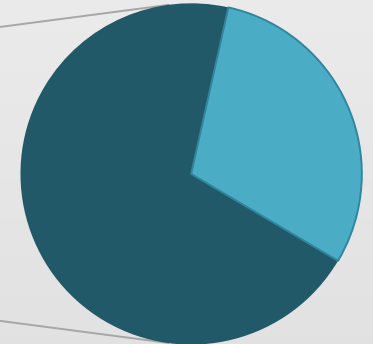

OVER-REPRESENTATION OF PEOPLE WITH MENTAL ILLNESS: THE OHIO STORY

- In Ohio prisons
 - Total inmates = 50,556 (Jan 2017)
 - 20% mental health caseload: 9% classified SMI; percentage typically double for female population MI
 - 7 times rate of substance abuse as the general population (13,856 DRC inmates involved in Recovery Services CY15)
- Ohio Department of Mental Health and Addiction Services completed 1652 community linkage packets for persons identified as SPMI in calendar year 2015.
 - On average 3/4 substance abuse and 1/2 trauma history
- In Ohio psychiatric hospitals
 - 1,040 individuals (9/14/16)
 - As of June 2016, 69% are “forensic patients”

“Unsequential” Model

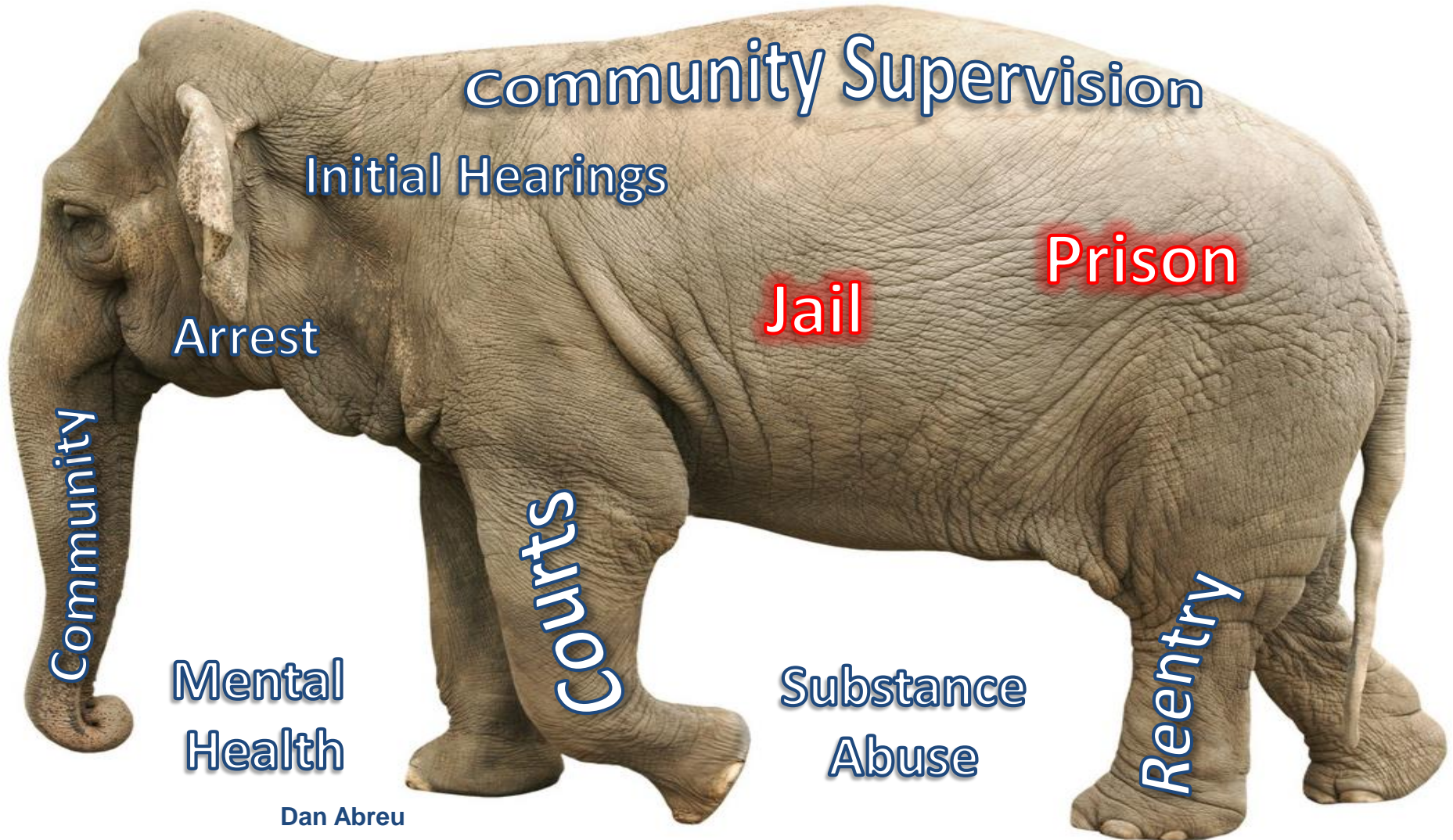

A SYSTEMATIC APPROACH TO THE CRIMINALIZATION PROBLEM

- There is no single solution to the problem we are calling “criminalization of people with mental illness”
 - People move through the criminal justice system in predictable ways
 - The problem must be attacked from multiple levels
 - The Sequential Intercept Model

SEQUENTIAL INTERCEPTS

Best Clinical Practices: The Ultimate Intercept

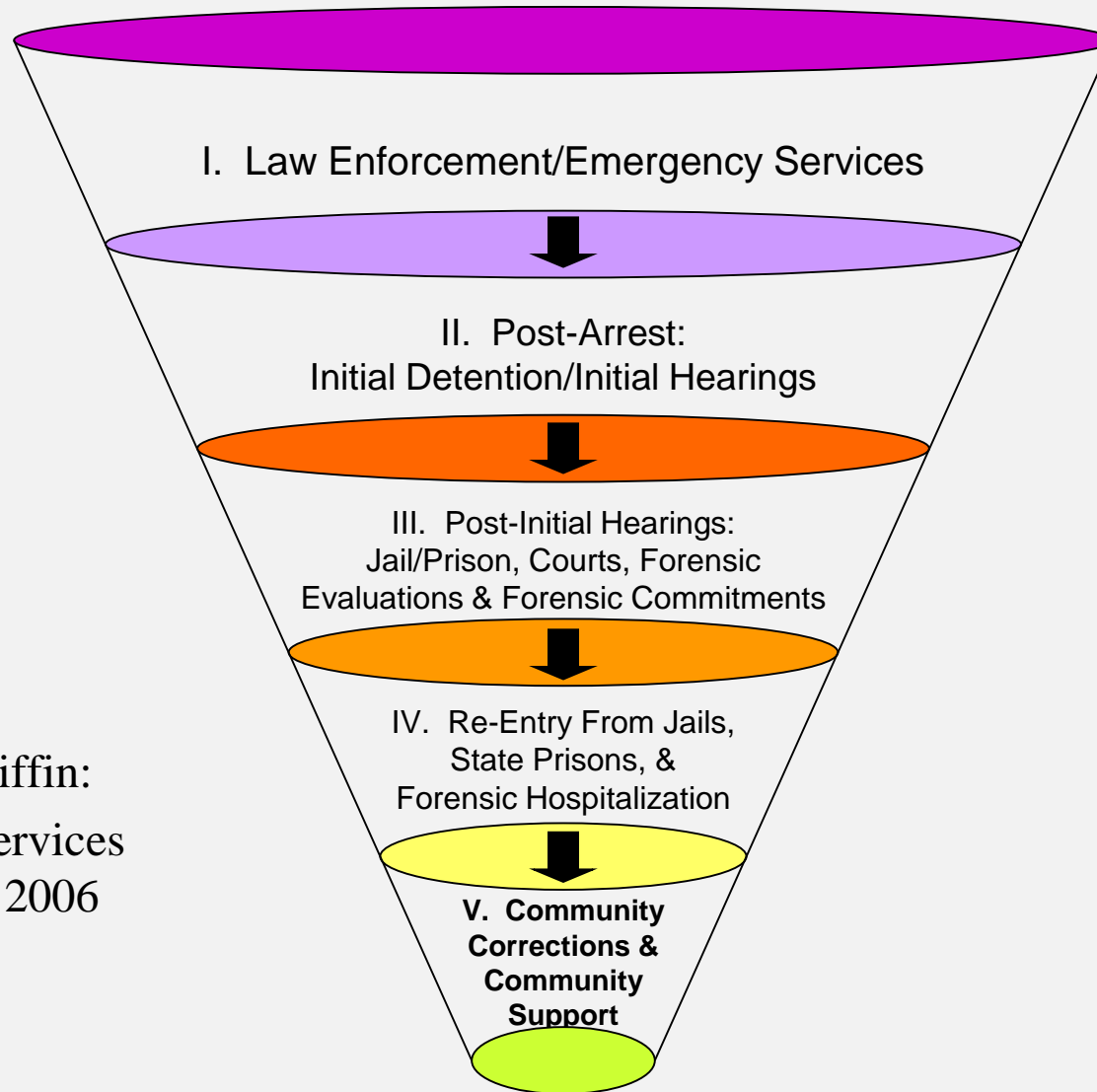

Munetz & Griffin:

Psychiatric Services

57: 544–549, 2006

SEQUENTIAL INTERCEPT MODEL

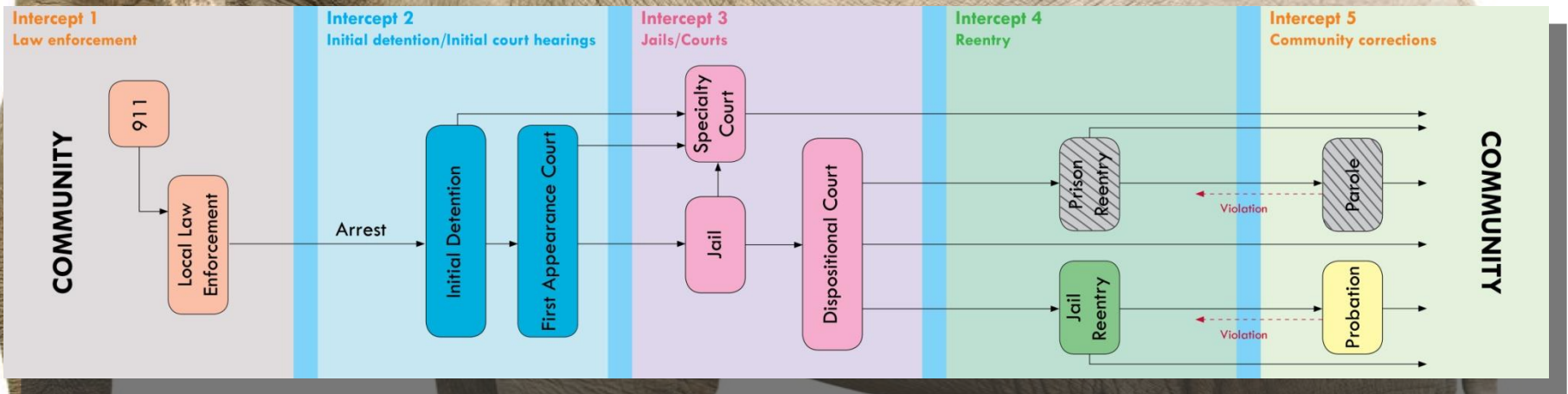

CROSS INTERCEPTS

- The GAINS Center has identified several system-level approaches relevant across all the intercepts.
 - Encourage and support collaboration among the stakeholders
 - Many of the cross intercept approaches are part of what we call the “ultimate intercept” i.e. an effective and accessible mental health & social service system
 - For example, supported housing, education and employment, peer support and other EBPs
 - Services which are culturally competent, gender specific and trauma informed
 - Services which address the specific needs of veterans
 - Recent attention to criminogenic risks and needs



OHIO CRIMINAL JUSTICE
COORDINATING CENTER
OF EXCELLENCE

Promoting Jail Diversion Alternatives for People with Mental Disorders

Effective Diversion:

A different way of doing business for
Criminal Justice, the Mental Health System,
consumers and their families

STEPPING UP INITIATIVE

- A National Initiative to Reduce the Number of People with Mental Illnesses in Jails
- Importance of diversion at pre-booking and pre-trial phases to be effective
- Measurement: Prevalence of Individuals with Mental Illness in Jail
- Must agree upon definition of mental illness for purpose of selecting data point and measuring progress

USE DATA TO TRACK OUTCOMES: SYNERGY WITH STEPPING UP

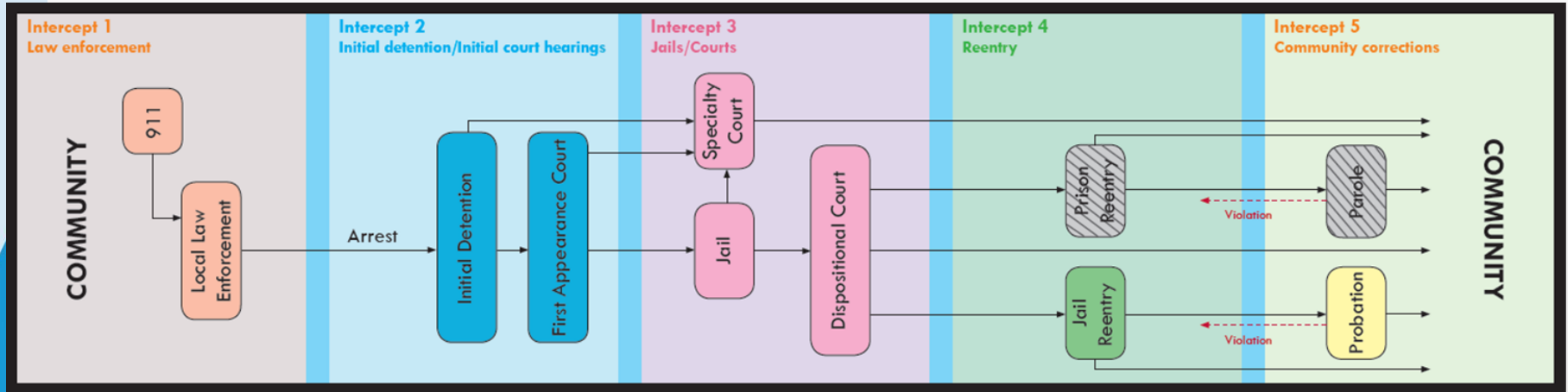

Outcome measures needed to evaluate impact and prioritize scarce resources

- 1. Reduce**
the number of people with mental illness booked into jail
- 2. Shorten**
the length of stay for people with mental illnesses in jails
- 3. Increase**
the percentage of people with mental illnesses in jail connected to the right services and supports
- 4. Lower**
rates of recidivism

ROLE OF DEFENSE COUNSEL IN STEPPING UP

- Effective, informed counsel
- Knowing local cross-systems goals and expectations for serving this population
- Early Access to counsel can improve outcomes
- Open dialog with prosecutors

OHIOMHAS – STEPPING UP

- Website
- Local, State and National Resources

<http://mha.ohio.gov/Default.aspx?tabid=852>

TECHNICAL ASSISTANCE – CJ CCOE & OHIOMAS

- Trainers and Consultants
- Websites
- Email distribution lists
- Lending Library
- Local, State and National Resources
- Guidance on Best Practices and Evidence-based Practices
- Peer networking



Ohio Criminal Justice Coordinating Center of Excellence

Ruth H. Simer, M.Ed., LSW

Director

4209 State Route 44

Rootstown, OH 44272

PH: (330) 325-6670

FAX: (330) 325-5970

www.neomed.edu/cjccoe

